

# VEGAS 2

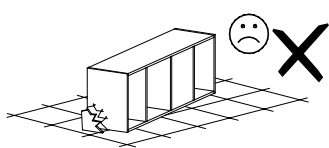

Narzędzia potrzebne do montażu

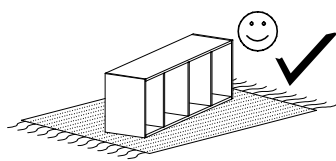
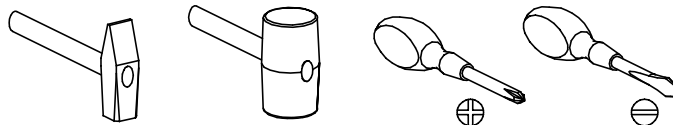

## **UWAGA !!!**

**MONTOWANIE USZKODZONYCH  
ELEMENTÓW POWODUJE UTRATĘ  
GWARANCJI**

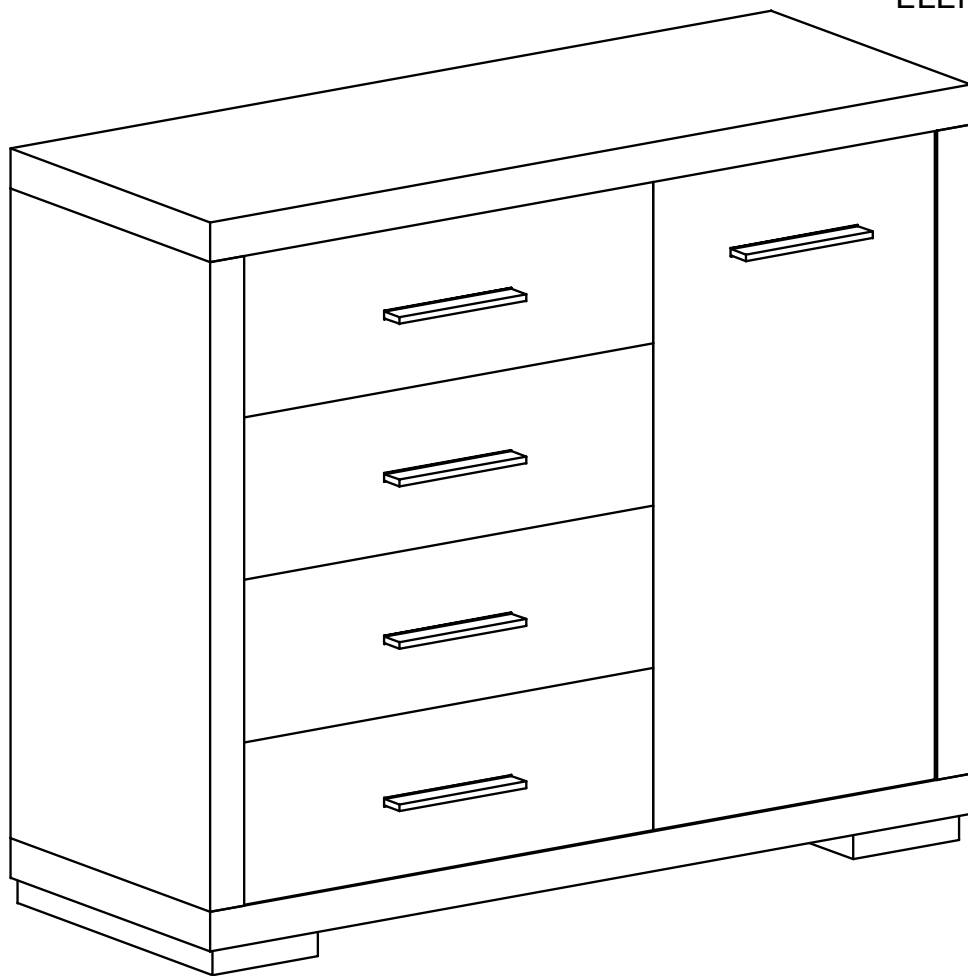

Nr	D[mm]	S[mm]	G[mm]	Ilość
1	1082	407	48	1
2	1082	407	48	1
3	783	405	48	1
4	780	388	16	1
5	783	405	48	1
6	394	320	16	1
7	773	368	16	1
8	1070	834	2,5	1
9	603	190	16	4
10	546	165	16	4
11	350	165	16	4
12	350	165	16	4
13	575	355	2,5	4

W przypadku reklamacji proszę podać numer pakowacza znajdujący się na kartonie.

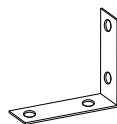

**Y - 2 St.**

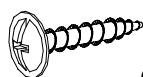

**Q - 4 St.**  
3,5x16 mm



**M - 65 St.**  
3x30 mm

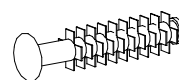

**F - 16 St.**

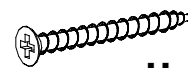

**H - 6 St.**  
4x60 mm

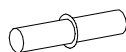

**P - 4 St.**



**N - 10 St.**  
4x30 mm



**U - 5 St.**



**G - 4 St.**  
3,5x16 mm



**L - 12 St.**

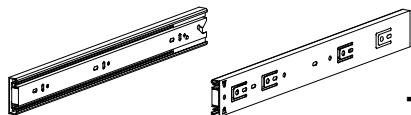

**T - 4 Kpl.**

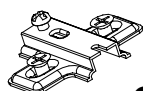

**C - 2 St.**

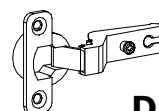

**D - 2 St.**



**S - 1 St.**



**E - 55 St.**

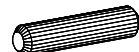

**B - 28 St.**

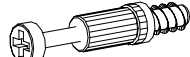

**K - 12 St.**

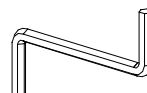

**Z - 1 St.**



**J - 32 St.**  
5x13 mm

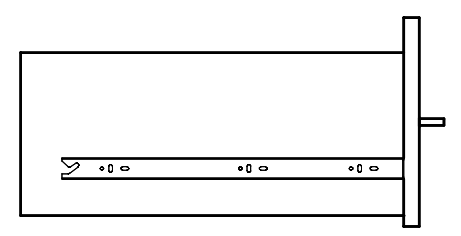
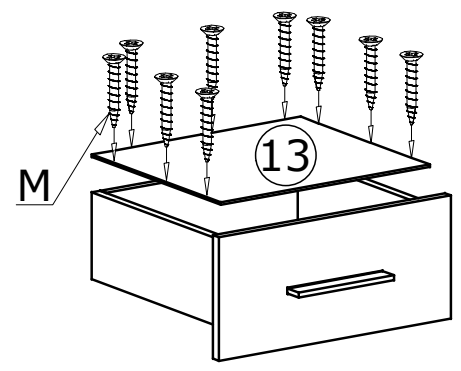
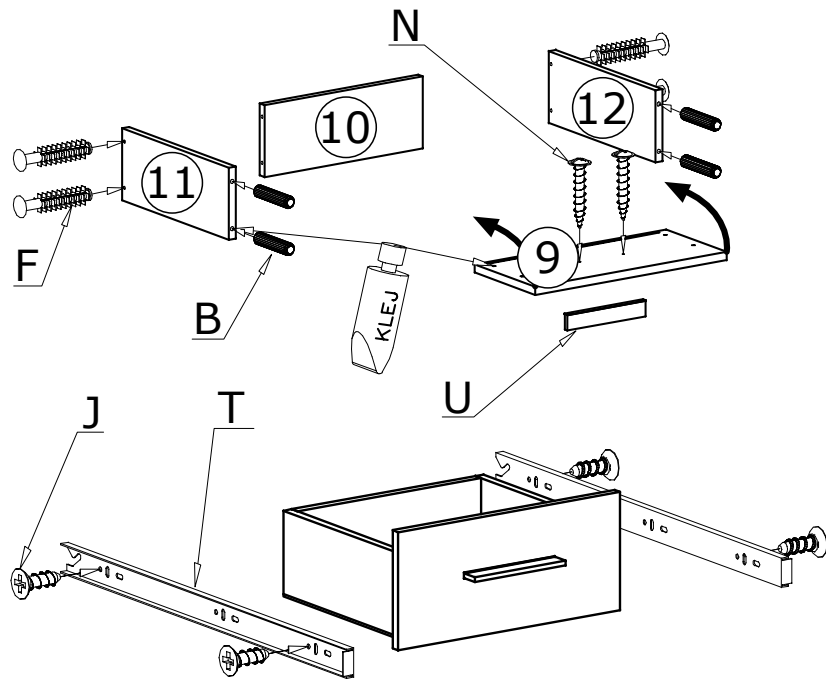
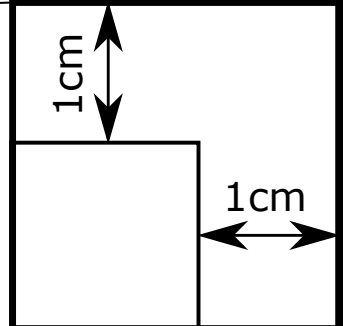
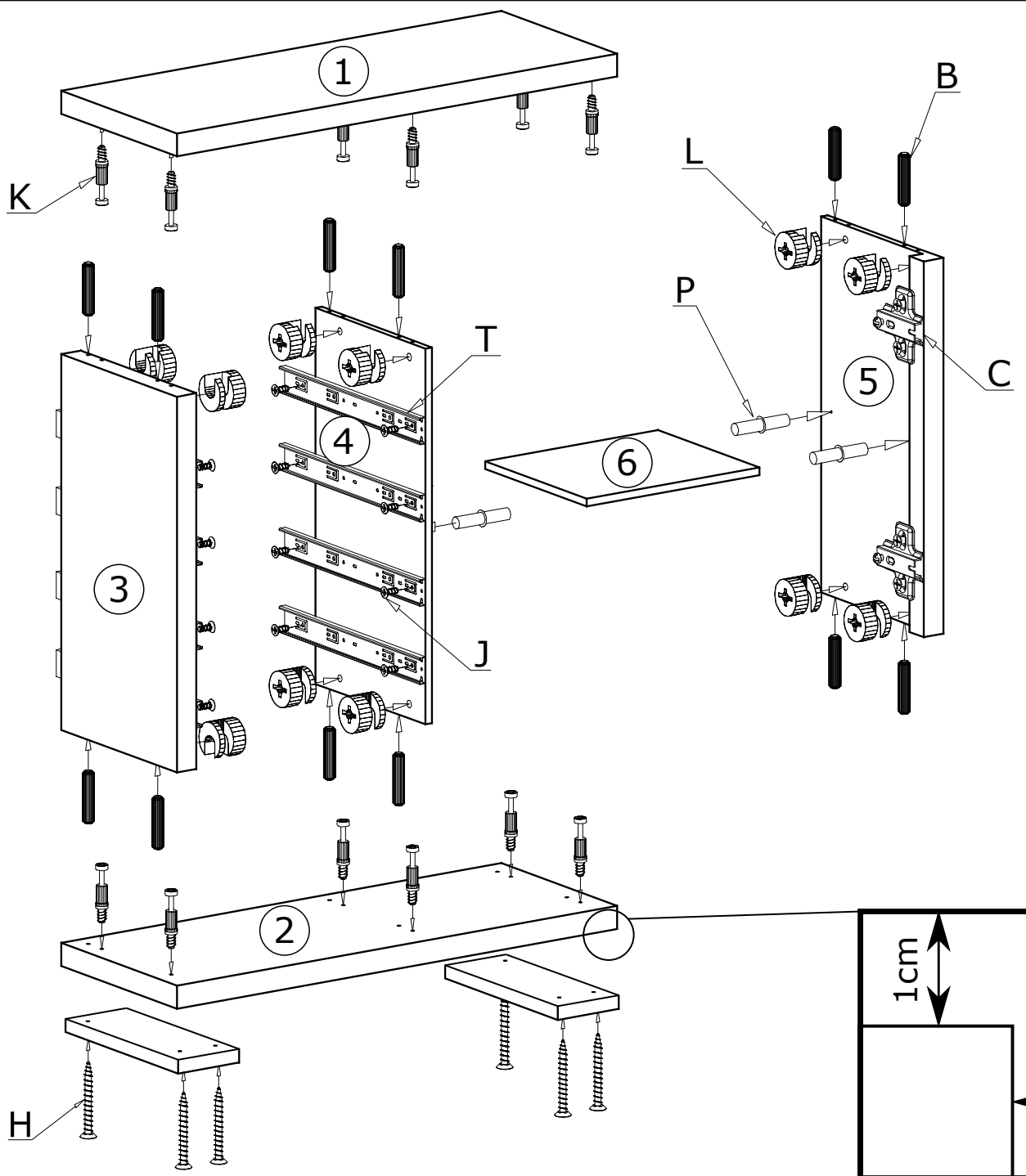

III

55X 

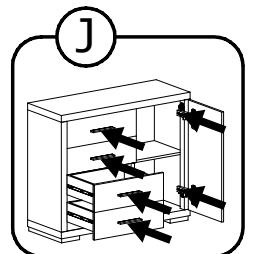
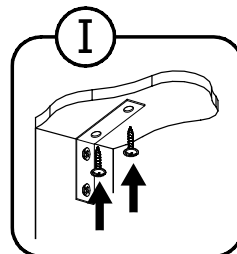
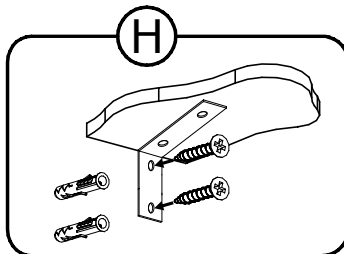
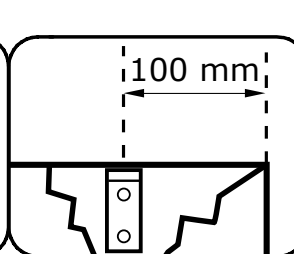
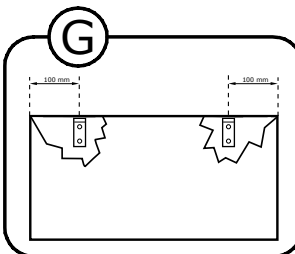
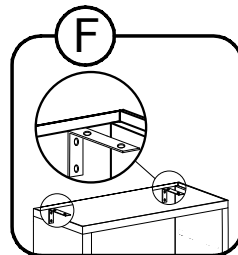
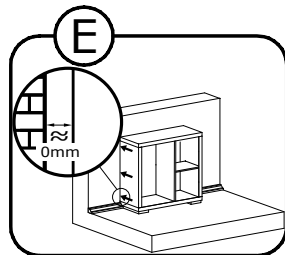
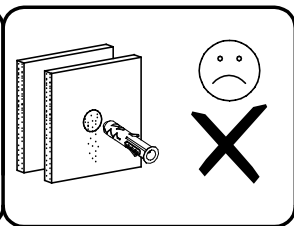
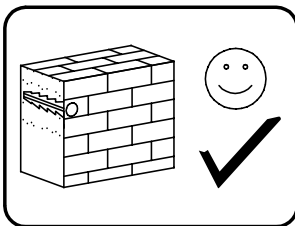
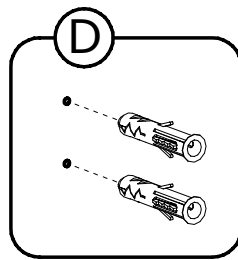
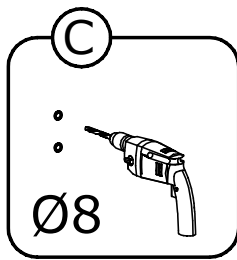
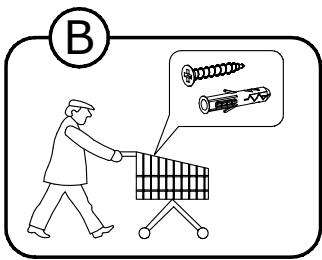
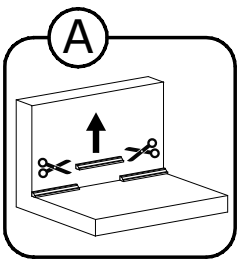
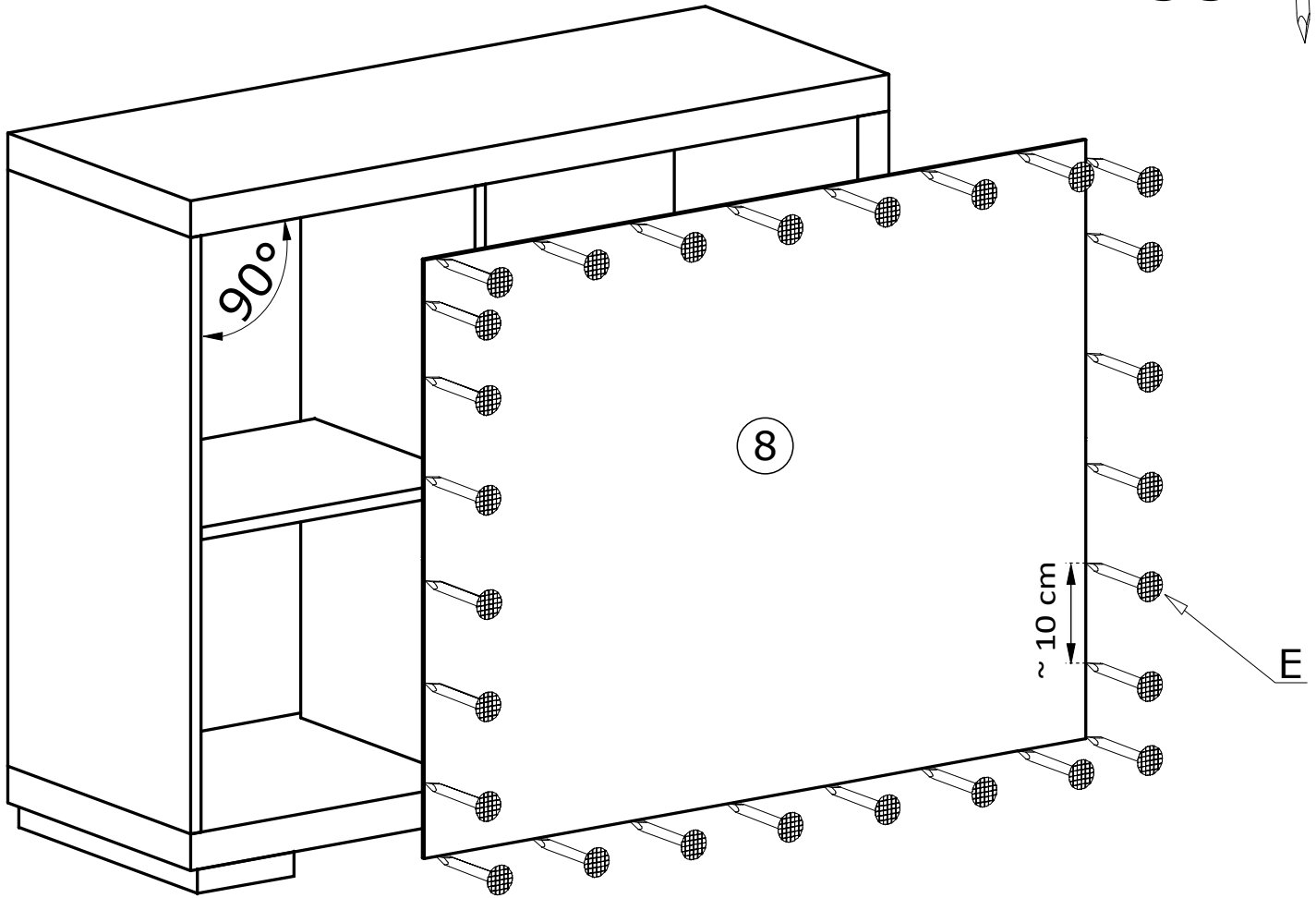

IV

