

IMPORTANT INFORMATION:

- 1) REMOVE THE PROTECTIVE FOIL IF THE TABLE IS IN HIGH GLOSS
- 2) HIGH GLOSS SURFACE HARDENING TIME IS 2 HOURS
- 3) AFTER 2 HOURS, TO CLEAN THE SURFACE, USE ONLY SOFT CLOTHS (E.G. COTTON OR MICROFIBRE CLOTHS AVAILABLE IN STORES). WASH THE SURFACE WITH A 1% MIXTURE OF SOAPY WATER

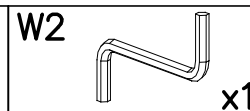

I

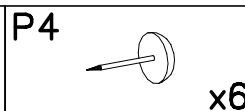
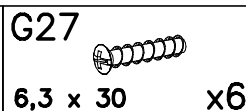
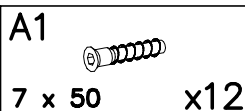
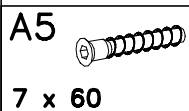
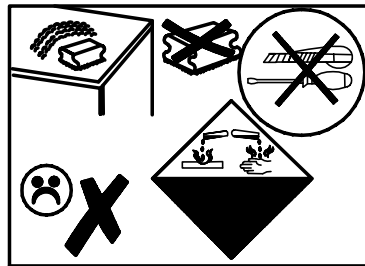
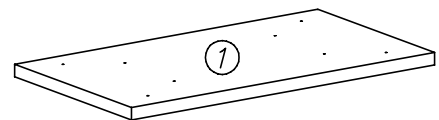
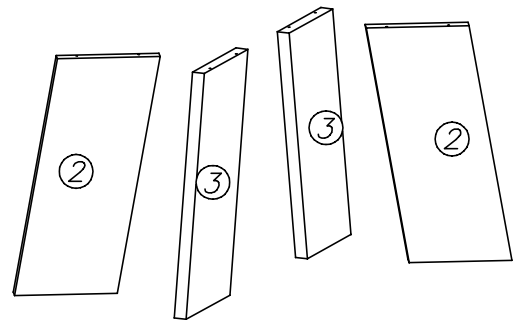
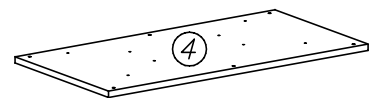
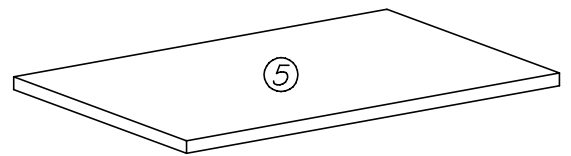
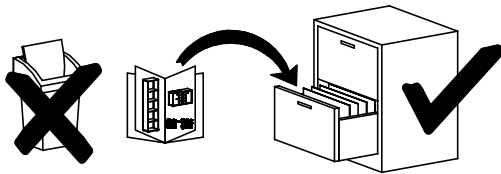
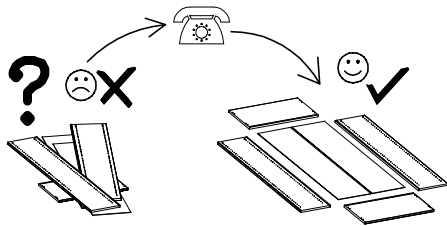
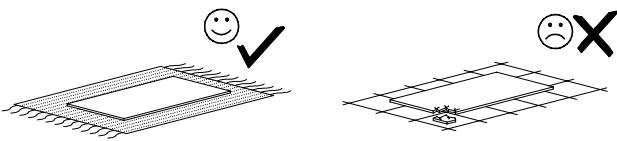
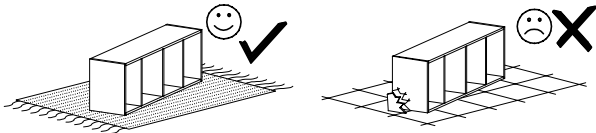
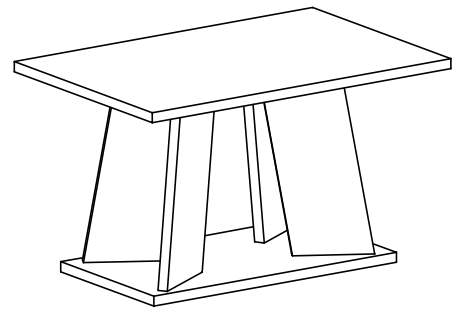
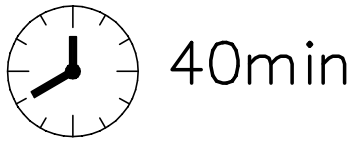
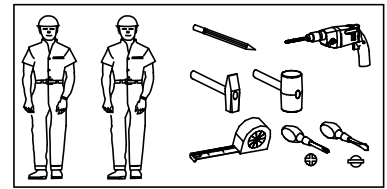
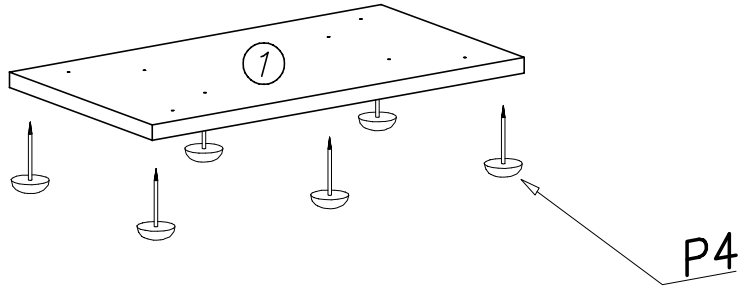

II

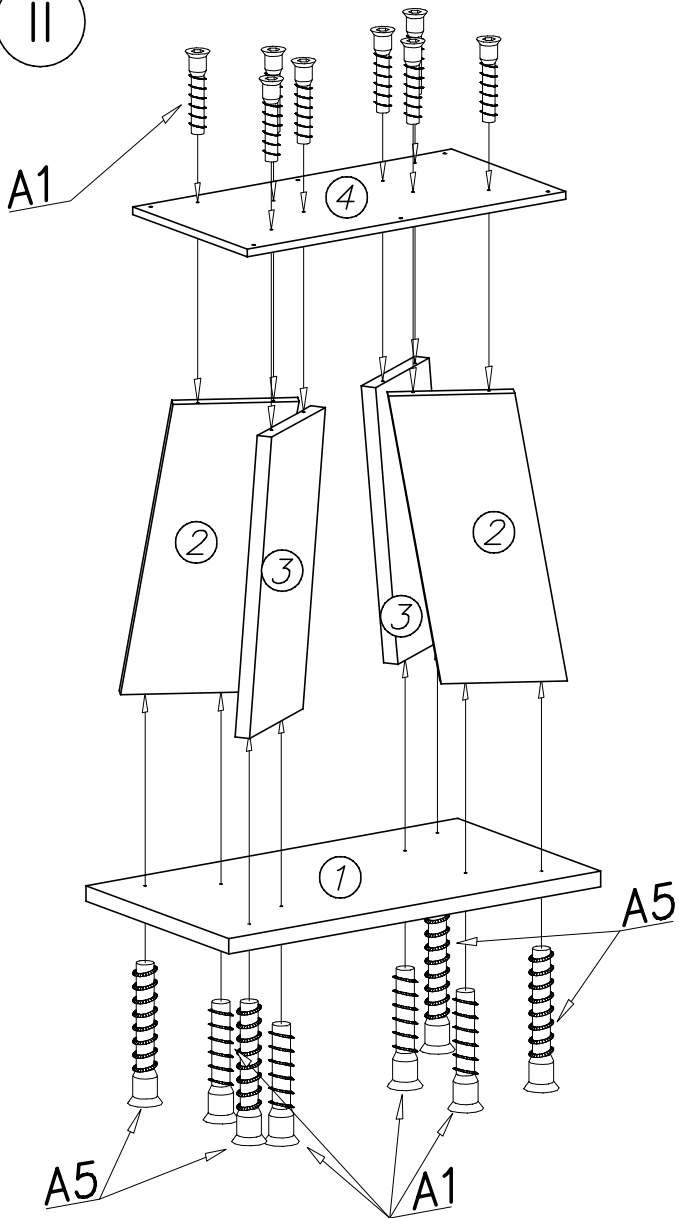

III

