

# VEGAS 39

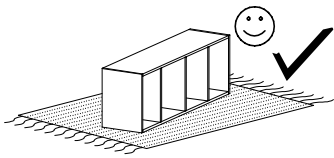

Narzędzia potrzebne do montażu

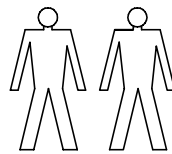
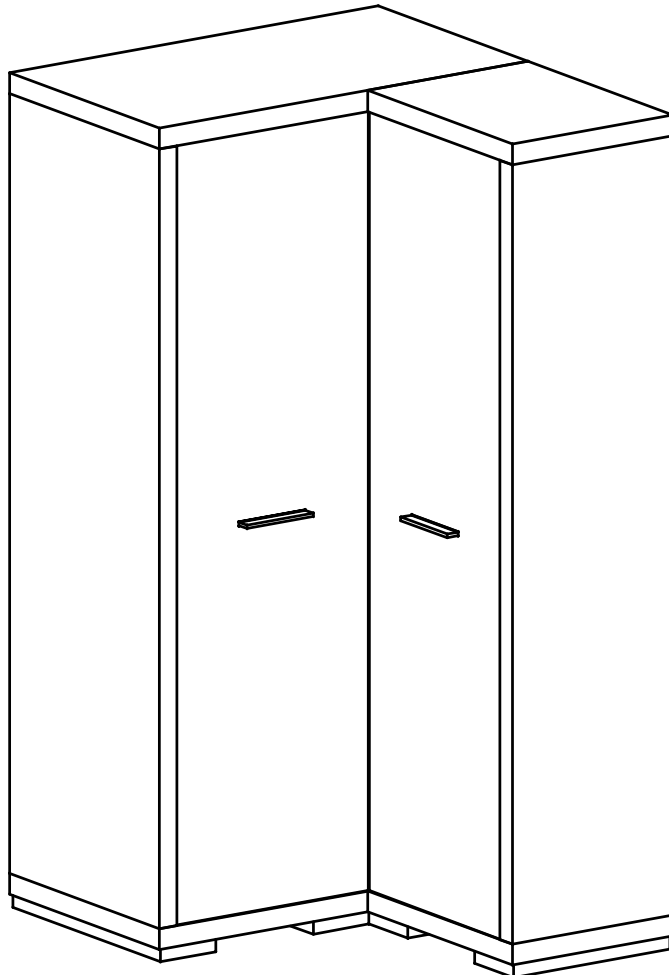
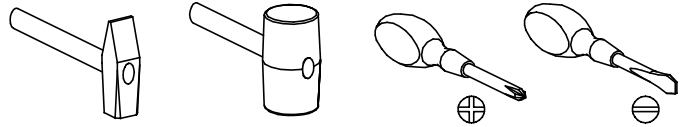

## UWAGA !!!

MONTOWANIE USZKODZONYCH  
ELEMENTÓW POWODUJE UTRATĘ  
GWARANCJI

Nr	D[mm]	S[mm]	G[mm]	Ilość
1	550	407	48	1
2	957	542	48	1
3	957	542	48	1
4	550	407	48	1
5	1793	405	48	1
6	1793	540	48	1
7	1790	405	16	4
8	1790	400	16	1
9	922	400	16	1
10	924	80	16	1
11	1820	948	2,5	1
12	1815	740	2,5	1
13	1782	495	16	1
14	1782	495	16	1
15	532	320	16	4

W przypadku reklamacji proszę podać numer pakowacza znajdujący się na kartonie.

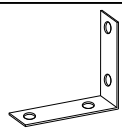

**Y - 2 St.**

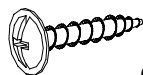

**Q - 4 St.**  
3,5x16 mm



**M - 1 St.**



**A - 2 St.**



**R - 10 St.**  
4x60 mm



**U - 2 St.**

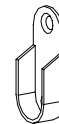

**T - 2 St.**

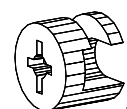

**L - 30 St.**

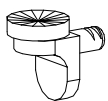

**I - 4 St.**



**N - 4 St.**  
4x30 mm

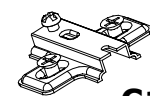

**C1 - 4 St.**



**G - 40 St.**  
3,5x16 mm

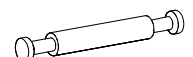

**F - 6 St.**

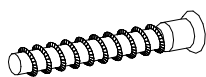

**W - 4 St.**



**E - 100 St.**

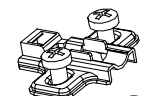

**C2 - 4 St.**

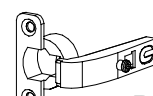

**D - 4 St.**

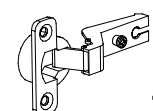

**J - 4 St.**

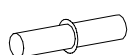

**P - 20 St.**



**B - 20 St.**

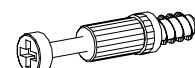

**K - 18 St.**

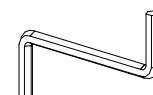

**Z - 1 St.**



**S - 6 St.**

I

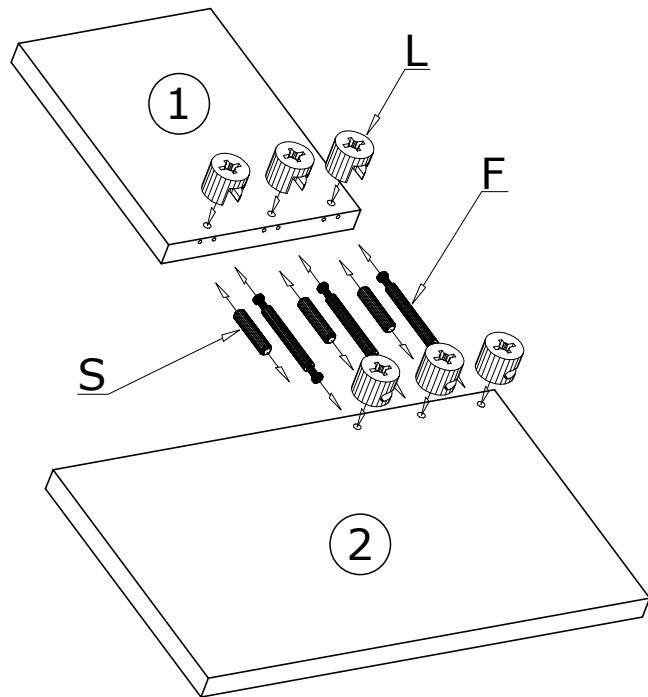

II

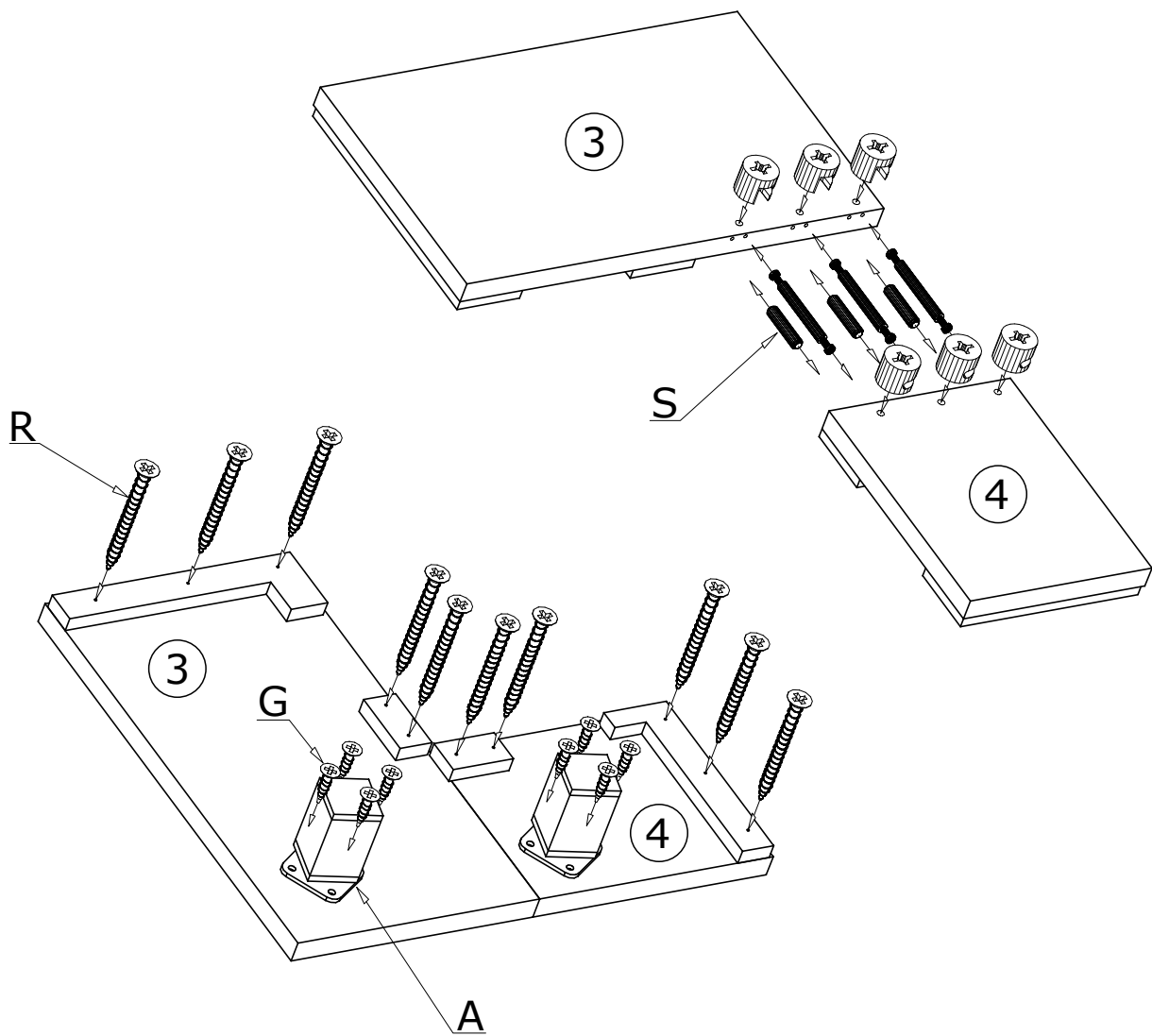

III

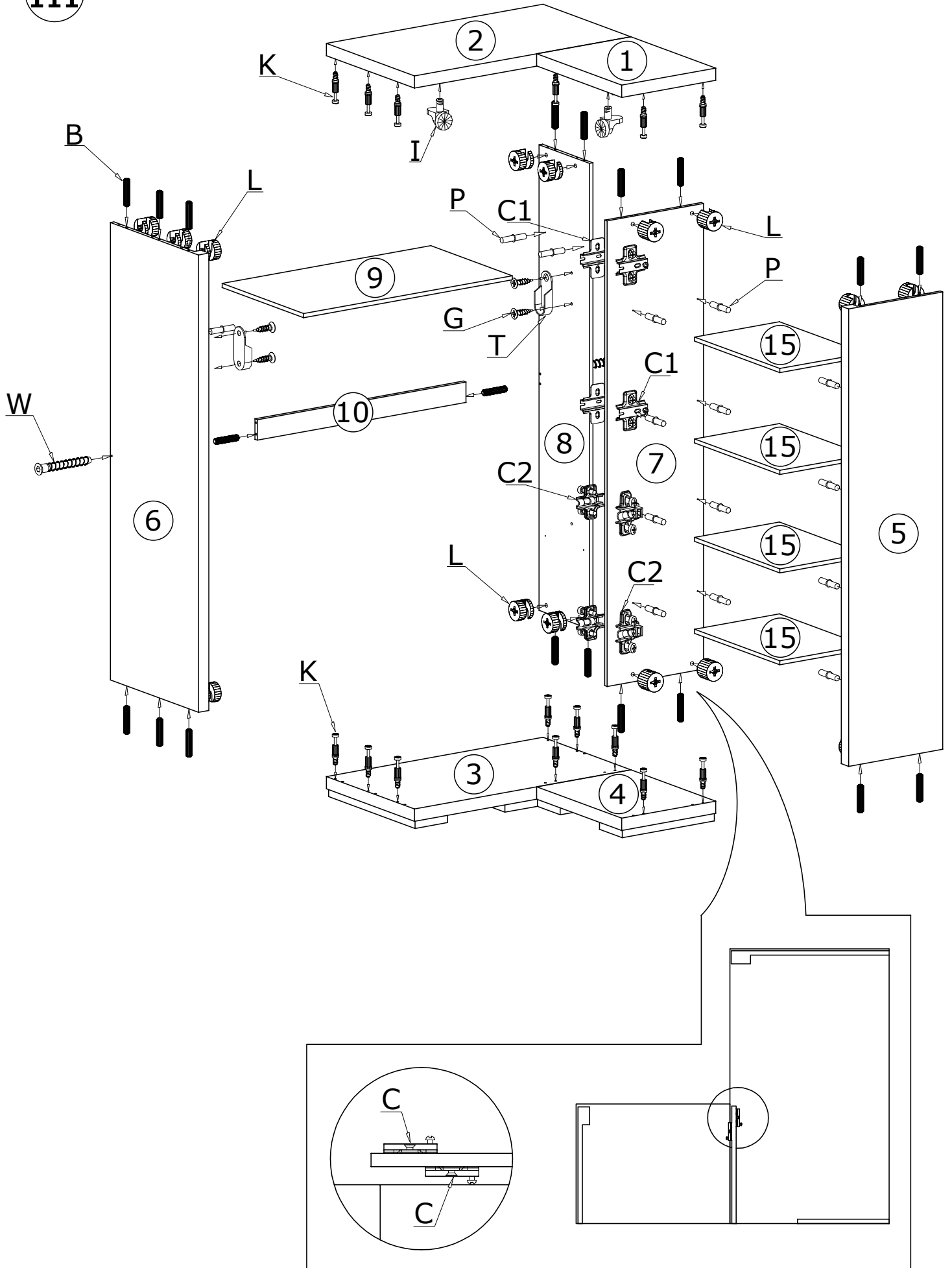

IV

100X 

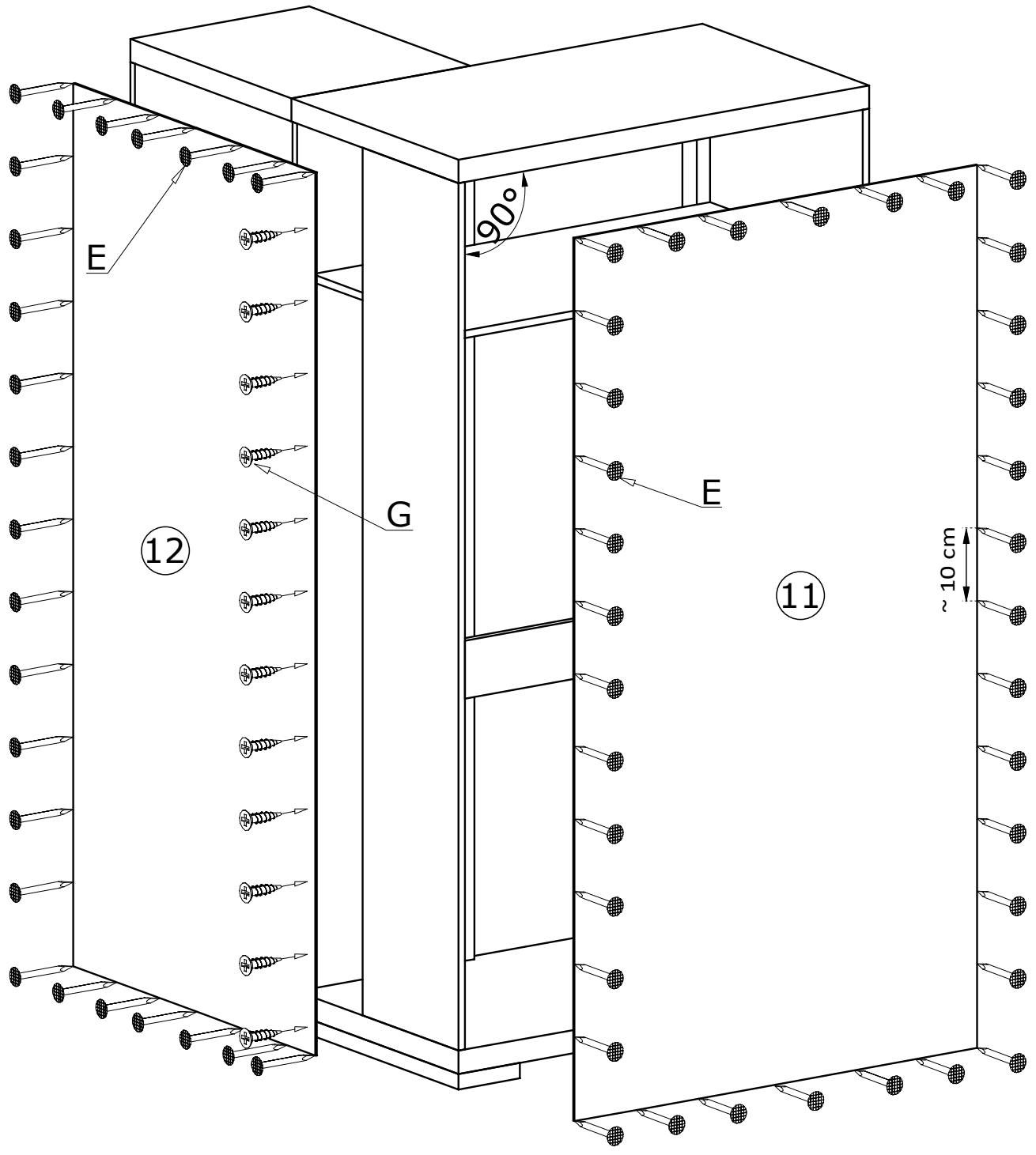

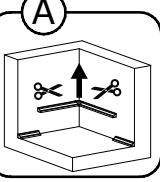
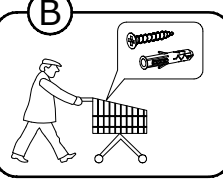
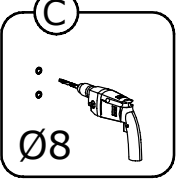
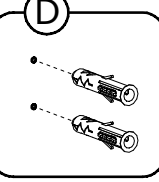
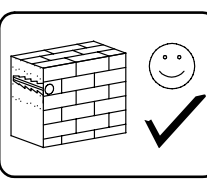
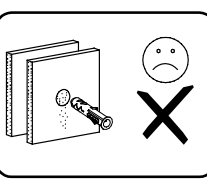
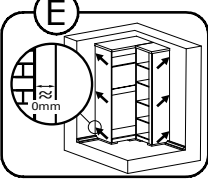
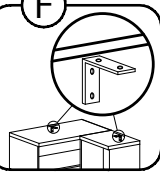
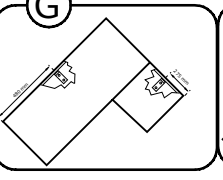
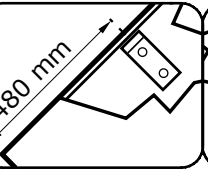
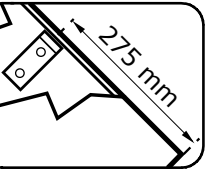
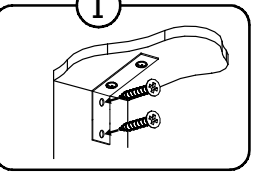
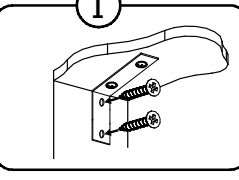
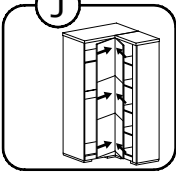
<b>A</b> 	<b>B</b> 	<b>C</b> 	<b>D</b> 			<b>E</b> 
<b>F</b> 	<b>G</b> 			<b>H</b> 	<b>I</b> 	<b>J</b> 

V

