

# VEGAS 1

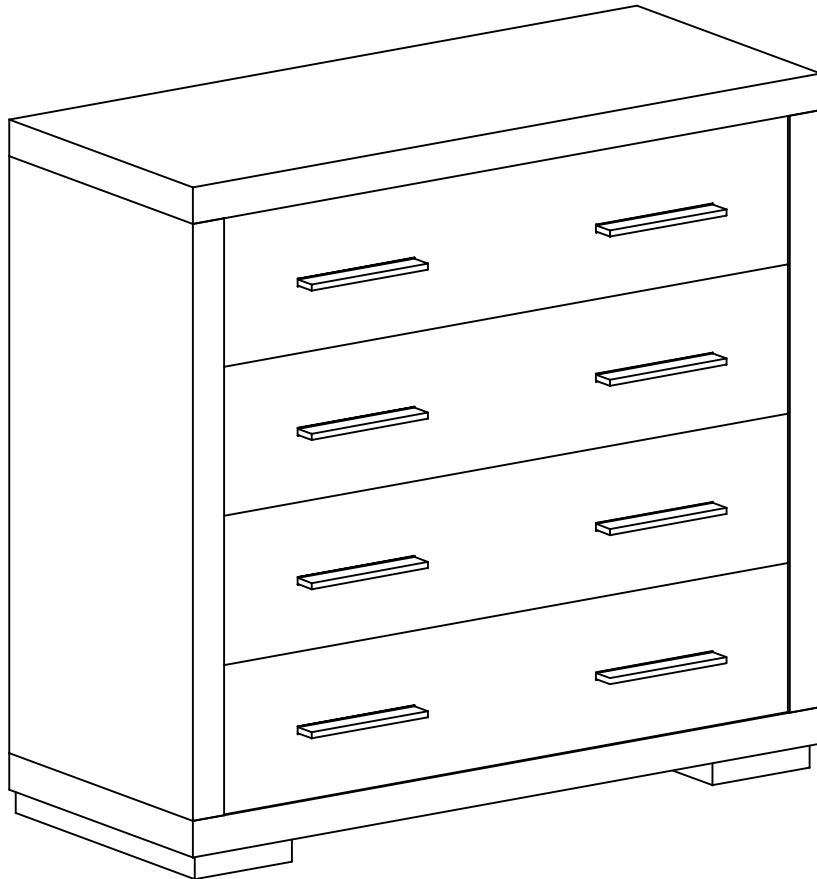

Narzędzia potrzebne do montażu

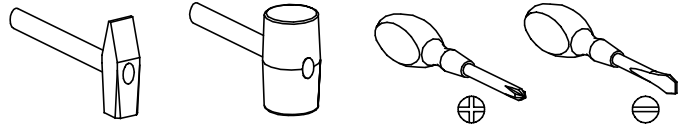

## UWAGA !!!

MONTOWANIE USZKODZONYCH  
ELEMENTÓW POWODUJE UTRATĘ  
GWARANCJI

Nr	D[mm]	S[mm]	G[mm]	Ilość
1	971	407	48	1
2	971	407	48	1
3	783	405	48	1
4	783	405	48	1
5	960	834	2,5	2
6	865	190	16	4
7	350	165	16	4
8	814	165	16	4
9	350	165	16	4
10	844	355	2,5	4

W przypadku reklamacji proszę podać numer pakowacza znajdujący się na kartonie.

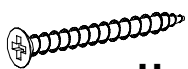

**H - 6 St.**  
4x60 mm



**X1 - 8 St.**

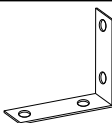

**Y - 2 St.**

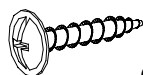

**Q - 4 St.**  
3,5x16 mm

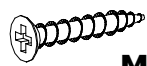

**M - 80 St.**  
3x30 mm

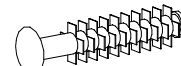

**F - 16 St.**



**L - 16 St.**

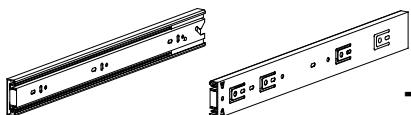

**T - 4 Kpl.**



**N - 16 St.**  
4x30 mm



**U - 8 St.**



**S - 1 St.**



**E - 40 St.**

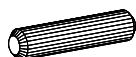

**B - 24 St.**

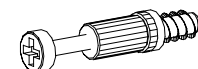

**K - 16 St.**

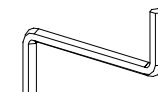

**Z - 1 St.**



**J - 32 St.**  
5x13 mm

I

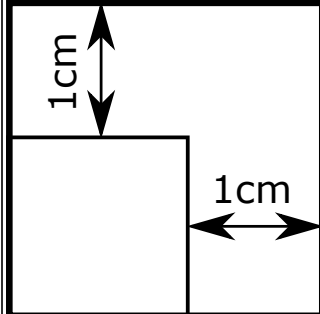
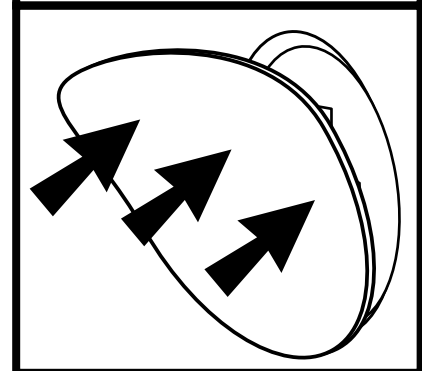
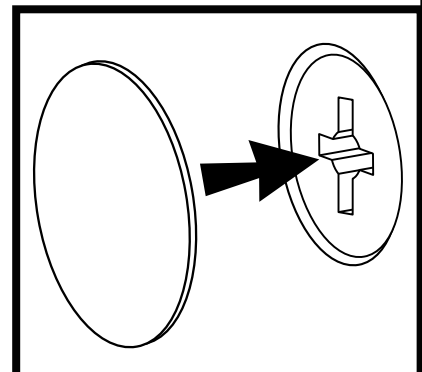
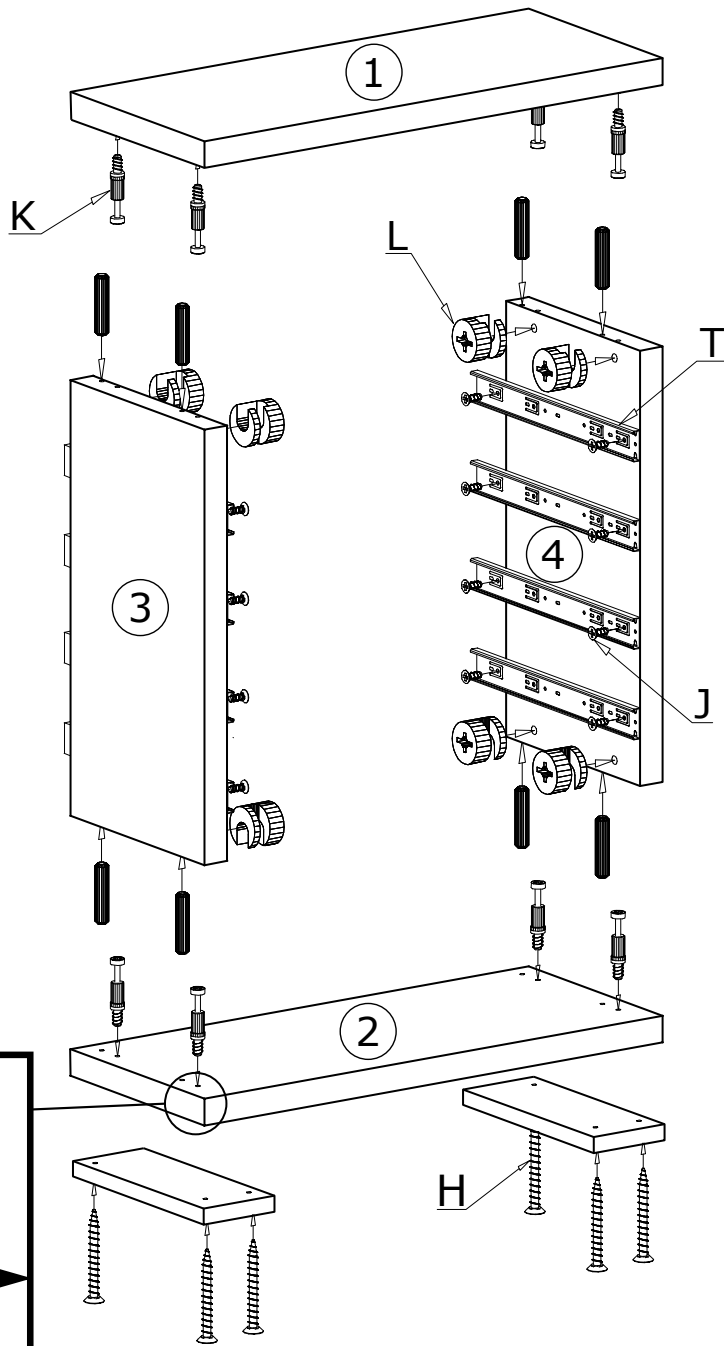

II

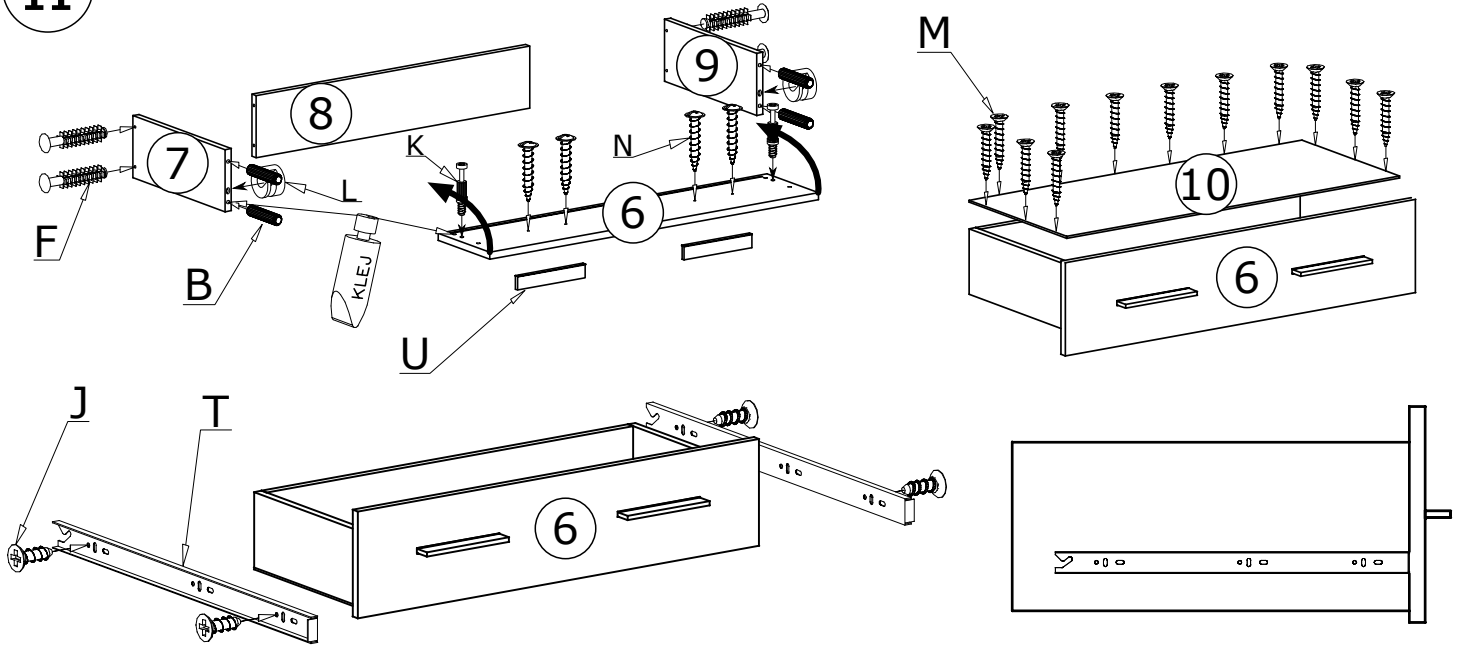

III

40X 

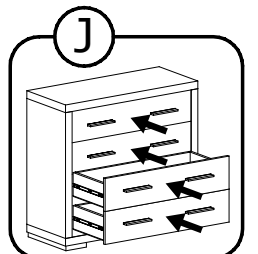
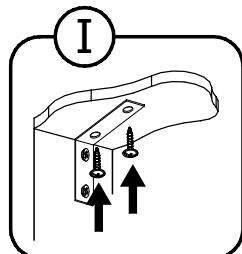
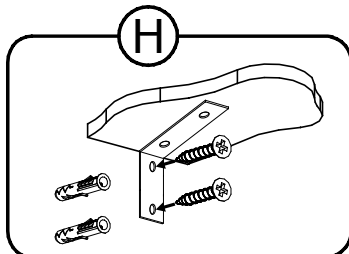
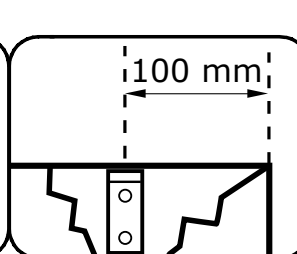
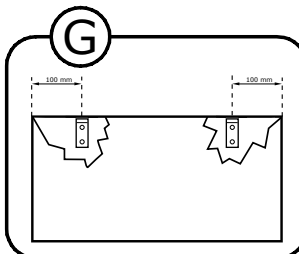
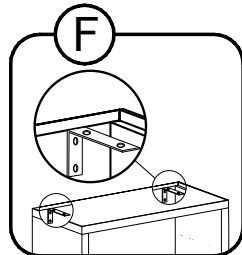
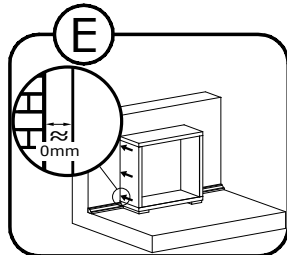
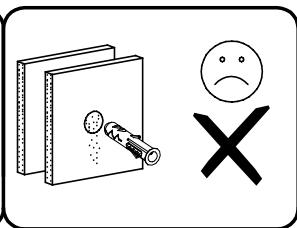
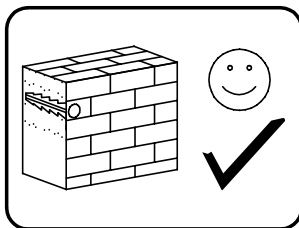
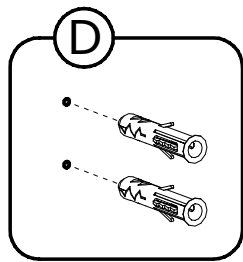
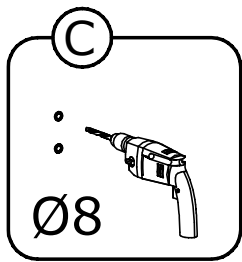
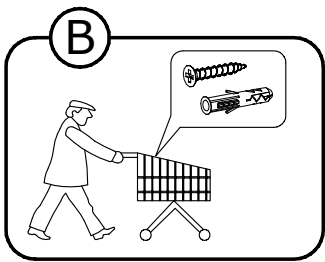
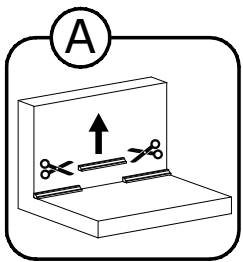
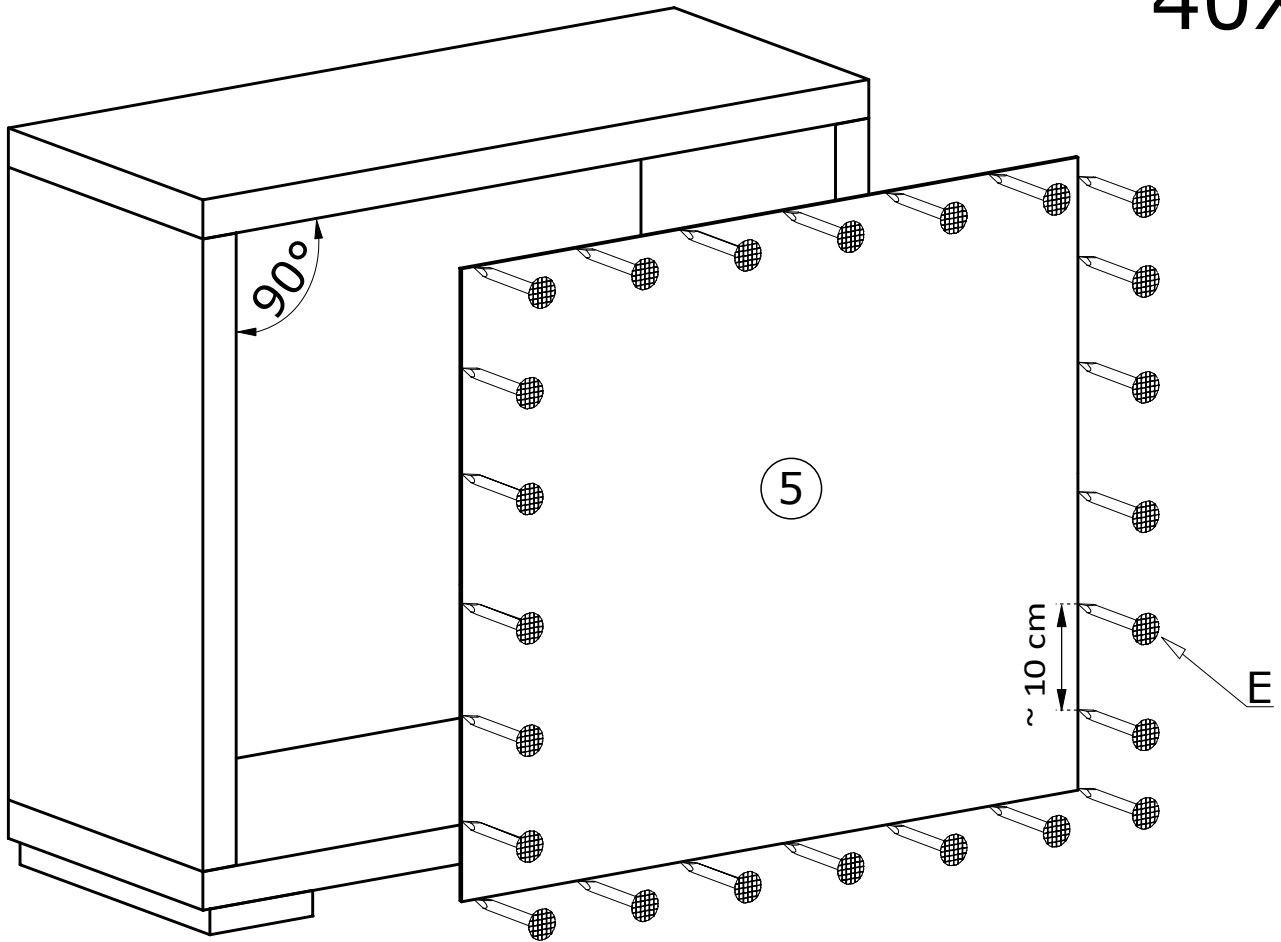

IV

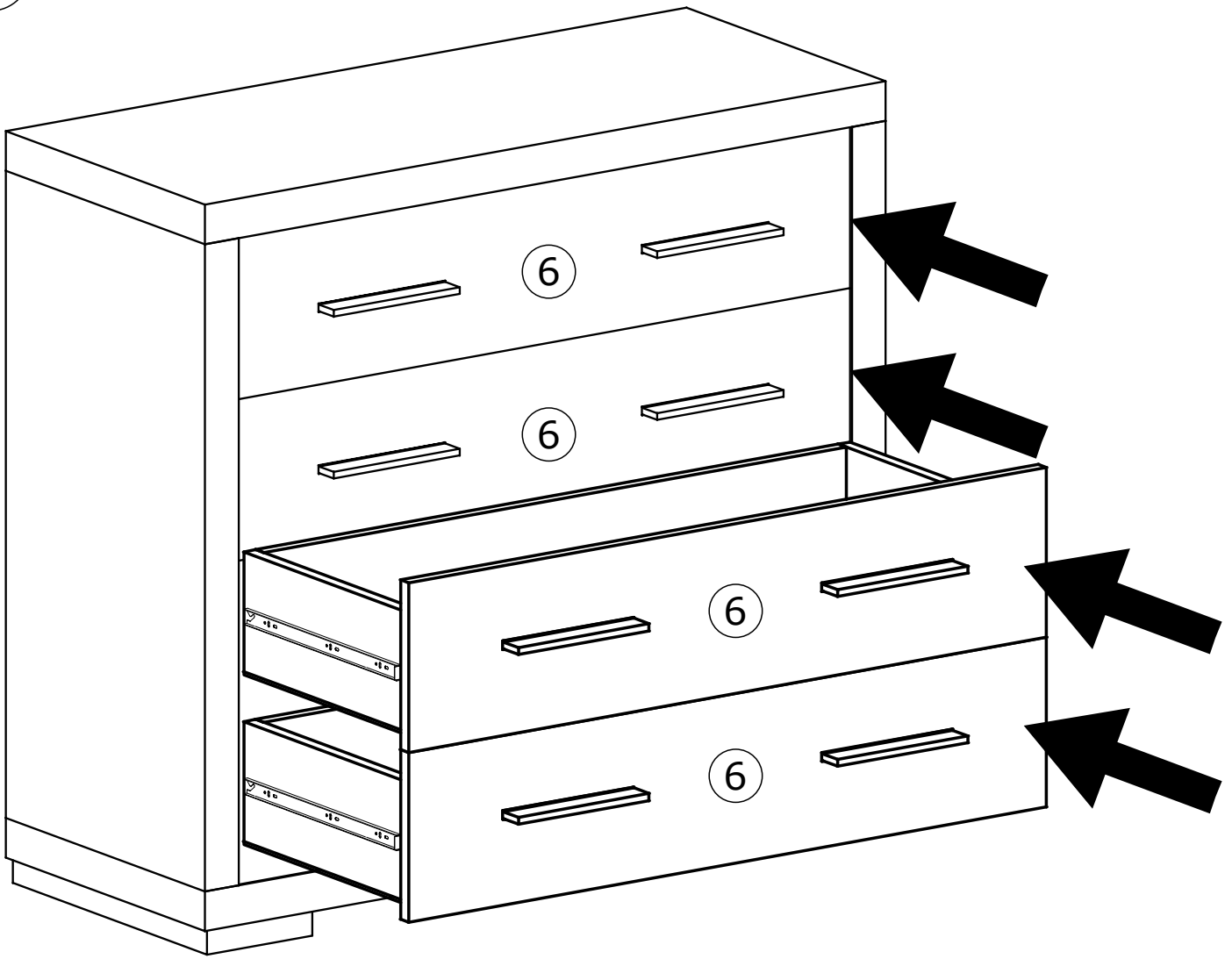

# MONTAŻ/DEMONTAŻ PROWADNIC

1



2



3

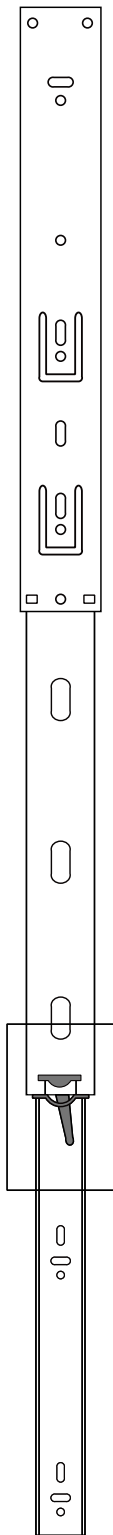

4

